

7400 Snaptrol Pneumatic & Electric Liquid Level Control, Low Pressure No-Bleed

Application

For use in low-pressure vessels or tanks, this versatile and multi-optional device can be used as a level control or as a component of Hi-Lo level alarm systems. The 1" MNPT unit may be mounted into a 1" coupling when the float is accessible from inside the vessel. If float is not accessible, a 2" or larger connection must be provided to allow passage of the float through the connection. The pneumatic 3-way 2-port no-bleed pilot valve makes this unit an excellent choice for the control of liquid level in oil and gas production equipment such as separators, dehydrators, treaters, as well as in manufacturing plants, hazardous waste disposal, food processing, petro-chemical facilities, or wherever fluid levels need to be monitored or controlled.

Features

- No-Bleed
- Cost Effective
- Pneumatic or Electric
- 1" and 2" Threaded or 4" Union
- Other Connections Available on Request
- Choices of Float Size and Float Arm Extension Length

Specifications

Size	1" Threaded	2" Threaded	4" Union
Body Working Pressure		500 psi	
Float			
Size	*2" x 6"	3" x 6"	**3 1/2" x 6"
Working Pressure	500 psi	500 psi	500 psi
Collapse Pressure	720 psi	850 psi	800 psi
Operating Temperature	... -40°F to +212°F (available to 400°F)		
Supply Pressure 75 psi (100 psi available)		
3-Way Pilot Connections 1/4" FNPT		
Material	1" Threaded	2" Threaded	4" Union
Body	836 Brz./A216 WCB	A216 WCB	A216 WCB
Float		Stainless Steel	
Float Arm		Stainless Steel	
Seals	Buna-N Standard (others available)		
Bushing (Retainer)	360 Brass (S.S. available)		
Electric Switch Explosion Proof		
Electric Switch, Single Pole / Double Throw, UL and CSA listed:	"L96" 15 amps, 125, 250, or 480 VAC; 1/8 HP-125 VAC, 1/4 HP-250 VAC, 1/2 amp-125 VDC, 1/4 amp-250 VDC		

*Standard on 2"

**Standard on 1" Threaded & 4" Union



Dimensional Data

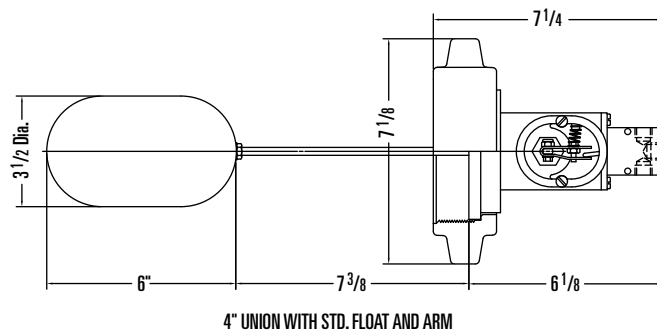
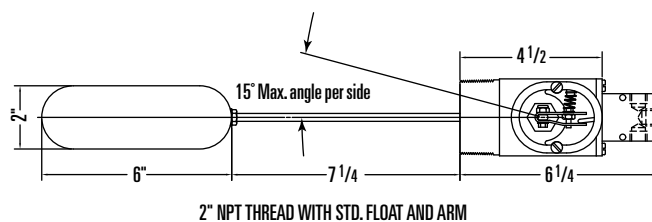
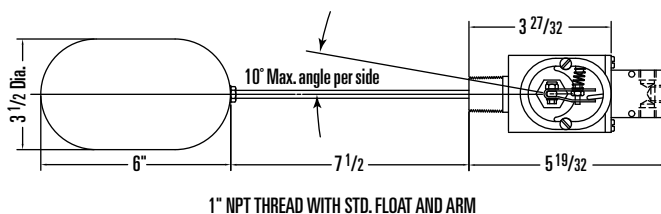

7400 Snaptrol Pneumatic & Electric Liquid Level Control, Low Pressure No-Bleed

Plumbing Schematic

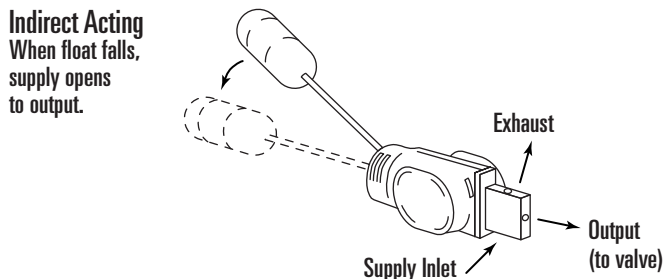
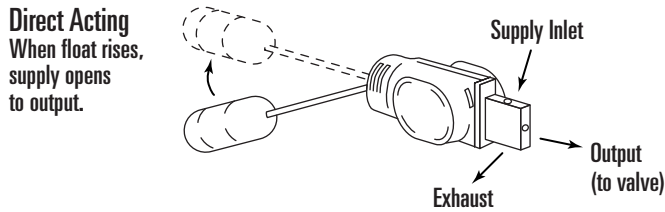

Determining the Model Number

Example given: Standard Model ST2TP - Series 7400, 2" Threaded Process Connection, Pneumatic Type Control.

MODEL ST2TP

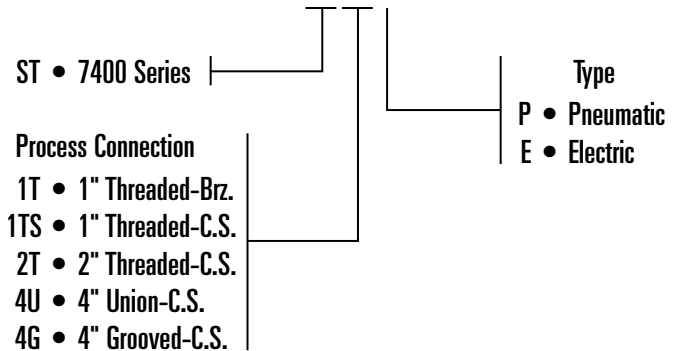

Parts List

Item	Description	Qty.	Part No.
1	NAME PLATE, ALUMINUM	1	10068
2	BEARING SLEEVE, DELRIN®	1	20031
3	TRUNNION, STAINLESS STEEL	1	20030
4*	O-RING, BUNA-N	1	05000-0041
5	FLOAT 2"X6", STAINLESS STEEL	1	10051
	FLOAT 3"X6", STAINLESS STEEL	1	10266
	FLOAT 3 1/2"X6", STAINLESS STEEL	1	10128
6	JAM NUT, STAINLESS STEEL	1	10007
7	FLOAT ARM, STAINLESS STEEL, 10" STD.	1	20028
8	BODY, 1" NPT PNEUMATIC, 836 BRONZE	1	40021
	BODY, 1" NPT PNEUMATIC, STEEL WCB	1	41077
	BODY, 2" NPT PNEUMATIC, STEEL WCB	1	40016
	BODY, 2" NPT ELECTRIC, STEEL WCB	1	40067
	BODY, 4" UNION, PNEUMATIC, STEEL WCB	1	40041
8	BODY, 4" UNION, ELECTRIC, STEEL WCB	1	40043
	BODY, 4" UNION, ELECTRIC, STEEL WCB	1	40043
9	BUSHING, 360 BRASS	1	20029
10	COVER PLATE, LEXAN	1	10050
11	COVER SCREW, STL. PLATED	4	10046
12*	O-RING, BUNA-N	1	10133
13	ACTUATOR, STAINLESS STEEL	1	10049
14*	3-WAY VALVE, PNEUMATIC ONLY	1	06000-0577
	ELECTRIC SWITCH, ELECTRIC ONLY	1	10219
15	SCREW, STL. PLATED	2	10041
16	SPRING, STAINLESS STEEL	1	10045
17	SPRING KEEPER, BRASS	1	20033
18	SCREW, STL. PLATED	2	10043
19	SCREW, STL. PLATED	2	10047
20	JAM NUT, STAINLESS STEEL	1	10060
21	LOCK NUT, STL. PLATED	1	10044
22	MOUNTING PLATE, ALUM. PNEUMATIC	1	20032
	MOUNTING PLATE 1, ELECTRIC	1	20185
	MOUNTING PLATE 2, ELECTRIC	1	20186
24*	HAMMER UNION, STD. V THREAD, WCB	1	05012-6705
	HAMMER UNION, ACME THREAD, WCB	1	05012-3702
25*	O-RING, BUNA-N, SCH. 80 WN (4" UNION ONLY)	1	05000-5446
	O-RING, BUNA-N, SCH. 160 WN (4" UNION ONLY)	1	05000-0561

*Recommended Spare Part

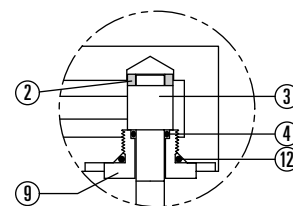
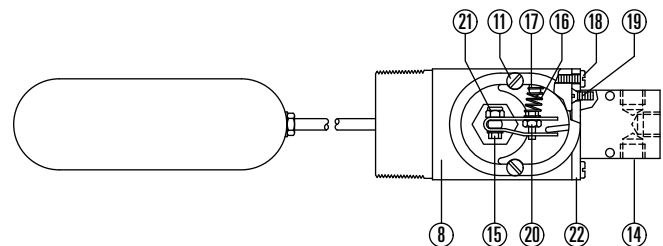
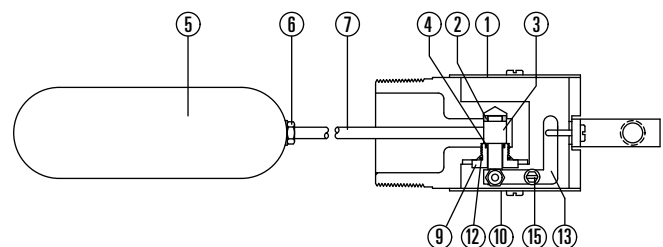

TRUNNION DETAIL